

SYSTEM FEATURES

- Allows gross and fine X,Y,Z & Theta movement while hand and arm are always supported
- Innovative, movable padded hand rest design to alleviate operator fatigue and discomfort
- AutoPick™ feature allows easy pick-up of parts such as melfs and small components from tape
- Quick changeover for left/right handed operators
- Large work area handles boards up to 16" x 24"
- Optional tape and stick feeders with feeder rack for more efficient component handling
- Precise Digital Dispenser with manual, semi-automatic, automatic and "learn" modes
- Movable, ESD Safe Component Bins slide in close to placement area
- Inline design with track hook-up provides progressive production (Push-Line) capabilities

The ergonomic solution to manual SMD pick & place



MPP-11
Benchtop pick & place with dispenser

MPP-10 & 11

- Work area handles board sizes up to 14" x 14"
- Movable, ESD Safe Component Bins slide in close to placement area
- Optional tape and stick feeders with feeder rack for more efficient component handling

SYSTEM DESCRIPTION

The MPP series allows an operator to accurately and efficiently place SMT components manually. Its patented hand rest and arm assembly alleviates operator fatigue by carrying the operator's hand throughout the entire process. The vacuum tip automatically toggles on and off during component pick-up and placement. The digitally timed dispenser accurately deposits solder paste, adhesives and various potting compounds.

Models MPP-10 and MPP-20 include the complete pick & place function.

Models MPP-11 and MPP-21 include both the pick & place and the four mode programmable dispenser.

All MPP systems come equipped with 40 movable ESD safe component bins (32- 1" x 1" and 8- 2" x 2", reconfigurable) which slide in close to placement area, movable padded hand rest, AutoPick™ feature, a left/right handed pick & place head, and an option for tape and stick feeders which can be added at any time.

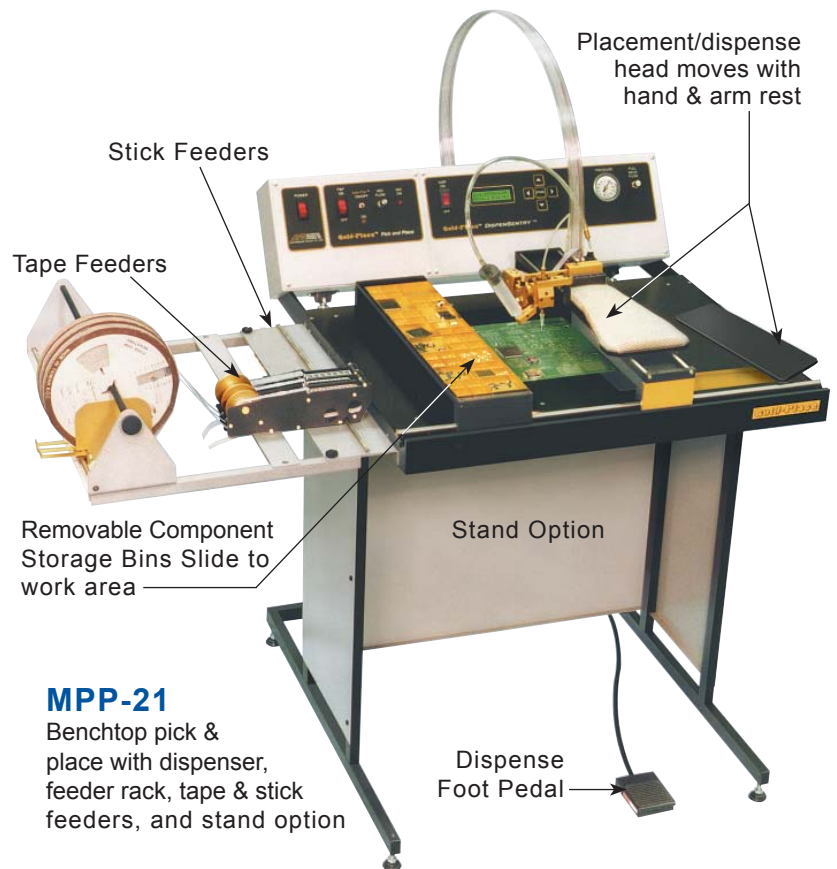

MPP-21
Benchtop pick & place with dispenser, feeder rack, tape & stick feeders, and stand option

MPP-20 & 21

- Large work area handles boards up to 16" x 24"
- Innovative, movable padded hand and elbow rest design to alleviate operator fatigue and discomfort
- Inline design with track hook-up provides progressive production (Push-Line) capabilities
- Stand option available



MPP-20
Benchtop pick & place shown with feeder rack, tape and stick feeders

The ergonomic solution to manual SMD pick & place

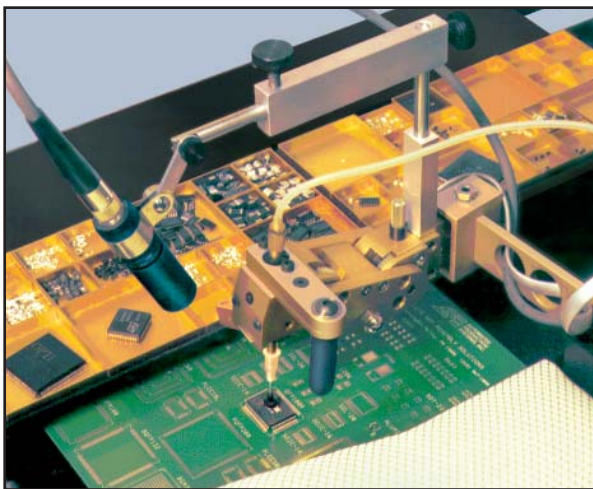

MPP-VC

VIDEO DISPLAY SYSTEM

- Enhances overall component placement capabilities
- Simple to attach and set up; easy to operate
- Fully adjustable viewing angle facilitates accurate placement
- Complete system includes 13" color monitor, CCD "lipstick" camera, video controller
- Compatible with all APS manual pick and place systems, models MPP-10, 11, 20 & 21
- Camera view remains focused on PCB during final placement operation

GDV-20

Fluid Dispenser with Vacuum Pencil

GDV-20 Dispensentry™ is a manual fluid dispenser for applying solder paste, adhesives or potting compounds etc. The programmable unit operates in 4 modes:

Manual mode for dispensing with the foot pedal.

Semi-auto mode for dispensing for a programmed amount of time.

Auto mode is for programmed interval and dispense times.

Learn mode stores real time dispensing for Semi or Auto use.

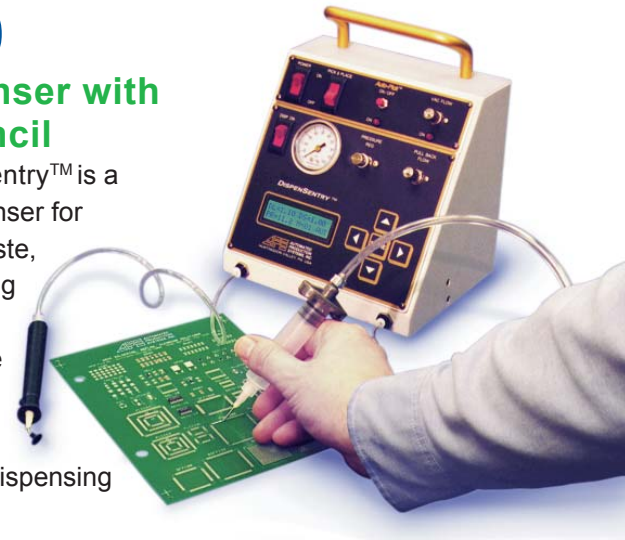

FEATURES & BENEFITS:

- Membrane keypad with LCD display
- Microprocessor control with 99 menu storage
- Automatic vacuum pull-back feature eliminates drips
- Vacuum pencil to aid in component placement
- AutoPick™ feature automatically activates vacuum (foot pedal deactivates) during component pick-up and placement
- Compact, portable unit

GDV-20 SPECIFICATIONS:

Power . . . 120/240 VAC, 50/60 Hz, 1 amp



Shop Air 30 psi min, 100 psi max

Dimensions 7.5" x 7" x 9"
(190 mm x 178 mm x 230 mm)

Weight

Manual SMD Pick & Place Series

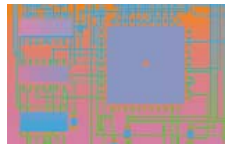
FEATURES AND SPECIFICATIONS

		
Model:	MPP-20/21	MPP-10/11
Max PCB size	16" x 24" (406 x 610mm)	14" x 14" (356 x 356mm)
Overall dimensions	25" x 28.5" x 7" 635 x 724 x 178mm	27.5" x 30" x 9" 700 x 762 x 230mm
Height with stand	35" (889mm)	Benchtop only
Power	120/240 VAC, 50/60 Hz, 1 amp	120/240 VAC, 50/60 Hz, 1 amp
Shop air*	100 psi max.	100 psi max.
4 mode digital dispenser	MPP-21, yes MPP-20, no dispenser	MPP-11, yes MPP-20, no dispenser
ESD safe conductive bins STD all models	1" x 1" bins: 64 max 2" x 2" bins: 16 max	1" x 1" bins: 64 max 2" x 2" bins: 16 max
Stand option	yes	no
Video Display System option MPP-VC	yes yes	
Slide-line connector kit option	yes 18.5" x 27.7"	no

*Self contained vacuum available upon request for pick & place

SYSTEMS AND ACCESSORIES

MPP-10.....	Manual Pick & Place System
MPP-11.....	Manual Pick & Place System with Dispenser
MPP-20.....	Manual Pick & Place System
MPP-21.....	Manual Pick & Place System with Dispenser
MPP-ST.....	Stand for MPP-20 and MPP-21
MPP-FR.....	Feeder Rack for Tape and Stick Feeder
MPP-VC.....	Video Display System
PTF-8.....	8mm Tape Feeder for MPP-Series
PTF-12.....	12mm Tape Feeder for MPP-Series
PTF-16.....	16mm Tape Feeder for MPP-Series
PTF-24.....	24mm Tape Feeder for MPP-Series
PST-8.....	8mm Stick Feeder for MPP-Series
PST-10.....	10mm Stick Feeder for MPP-Series
PST-14.....	14mm Stick Feeder for MPP-Series
MPP-BH.....	Extra board holder
MPP-TR.....	Storage tray (includes 4 2"x 2" & 16 1" x 1" Bins)
SLC-X.....	Slide-line connector kit for MPP-20 & 21

ACCESSORIES:



Stick Feeders

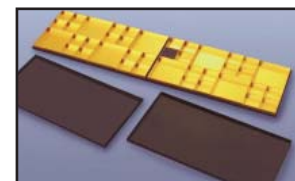

Storage Trays & Bins

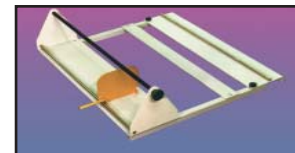

Feeder Rack



Tape Feeders

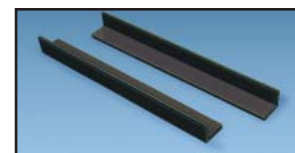

Magnetic Board Holders



Stand Option



Connector Kit

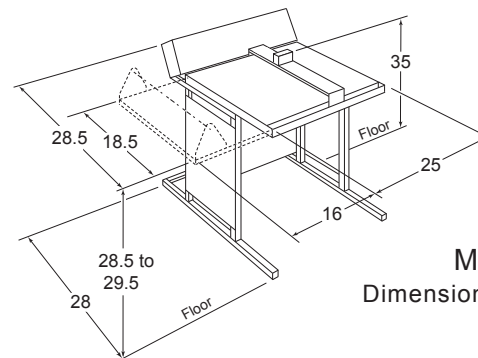

MPP-20/21
Dimensions in inches

Manual Placement Rate Comparison			
Average rate comparison for chip components			
METHOD	RA	PLACEMENT TE/HOUR	MAX COST/SMD PLACED @ \$8/HR
Tweezer		75 to 125	\$0.11
Vacuum Pencil		100 to 150	\$0.08
Manual Pick & Place		400 to 600	\$0.02
Sample cost comparison**			
Cost/SMD	x	SMD/board x	Board/lot = Cost/lot
\$0.11	x	50 x	100 = \$550.00
\$0.08	x	50 x	100 = \$400.00
\$0.02	x	50 x	100 = \$100.00

**savings vs tweezers is \$450.00 per lot

**savings vs vacuum pencil is \$300.00 per lot